



Almacén de Fontanería

COCINAS



FREGADEROS FIBRA

SETH 660 x 510



BLANCO
340800022
228,00 €

GRANITO
340800023
330,00 €

PEGASO 863 x 473



BLANCO
340800006
218,00 €

GRANITO
340800056
321,00 €

TROYA 450 x 450



BLANCO
340800015
152,00 €

GRANITO
340800065
222,00 €

ORION 822 x 496



BLANCO
340800012
209,00 €

GRANITO
340800062
310,00 €

DIANA 910 x 510



BLANCO
340800005
328,00 €

GRANITO
340800055
424,00 €

ATON 855 x 510



BLANCO
340800007
220,00 €

GRANITO
340800057
321,00 €

FREGADEROS SÍLICE QUARZ

REF. €

GARBI B/E (54,6x43,6cm)



991396003 289,00

COLORES SILK (BRILLO)

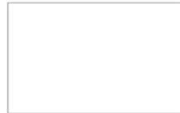

BLANCO

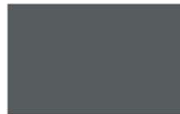

PLOMO



NEGRO



METALIZADO



SOMBRA



SILVER



CEMENTO



ARENA



SEDA

- MEDIDAS DE ENCASTRE -

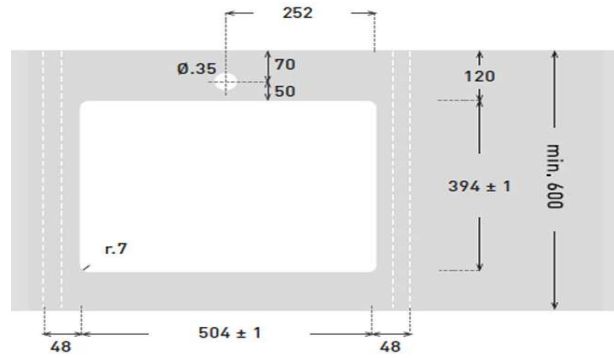

VICTORIA S/E (85x49,6xm)



991396002 249,00

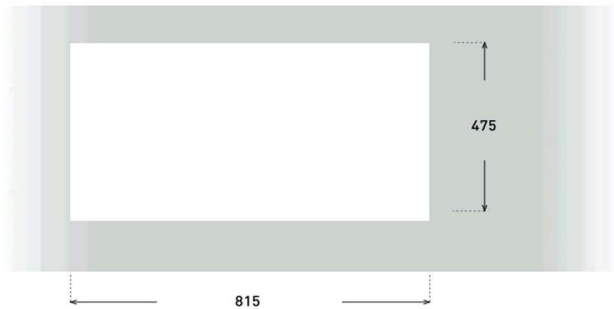

SOLUCION S/E (91,5x51,5cm)



991396001 289,00

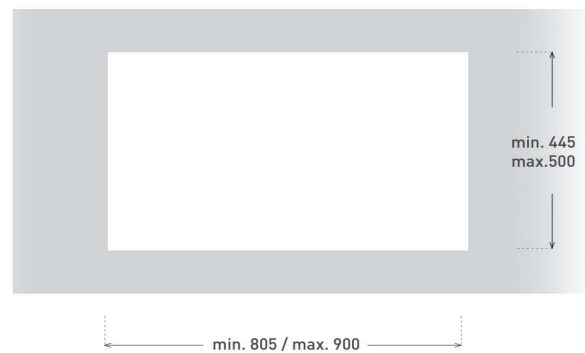

FREGADEROS GRANITO

REF. €



340725646 **AMSTERDAM 50 BL** 299,00
 340724646 **AMSTERDAM 40 BL** 289,00

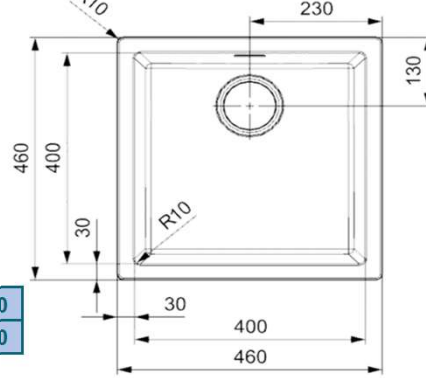
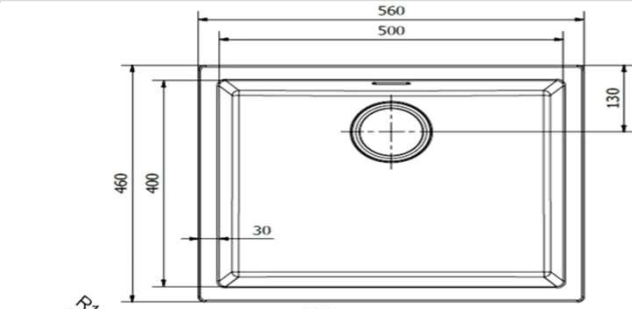

-  Blanco Puro
-  Crema
-  Gris Plateado
-  Negro Plateado



AMSTERDAM 72 405,00

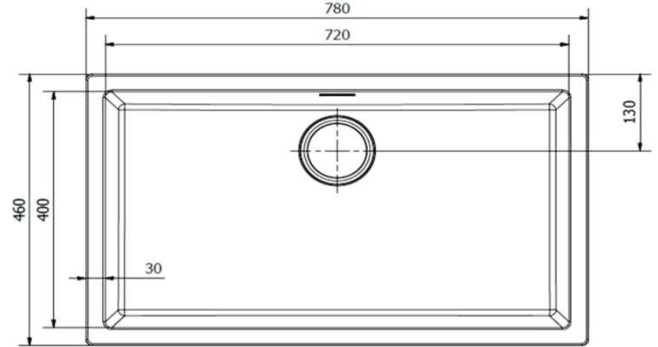



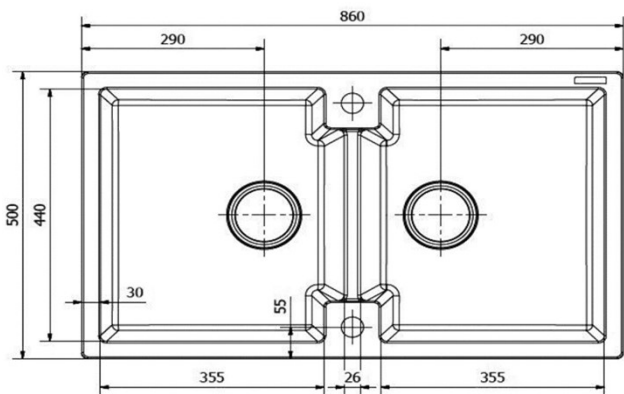



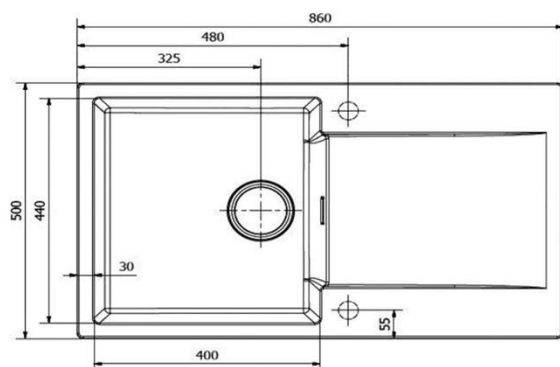



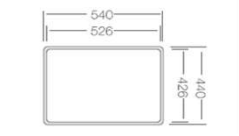
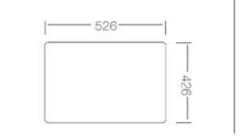
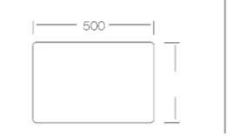
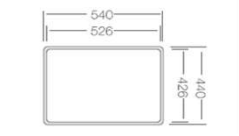
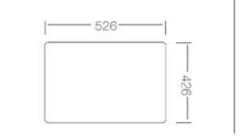
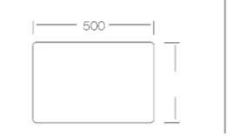
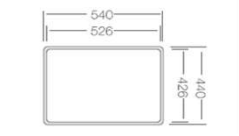
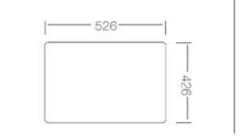
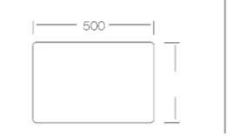
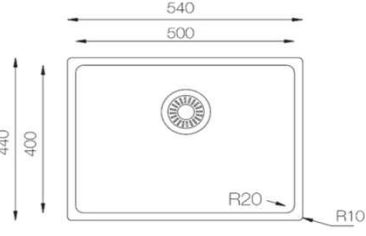

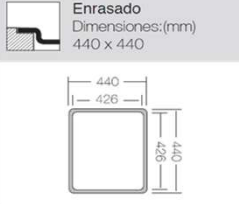
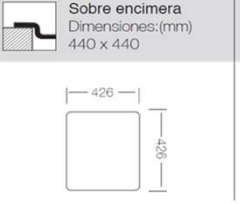
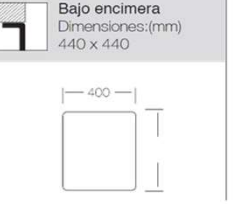
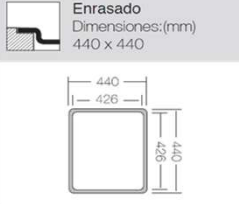
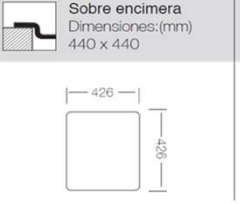
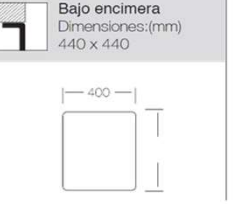
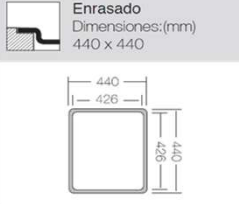
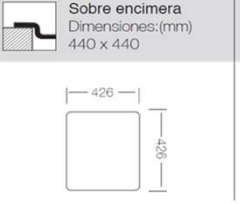
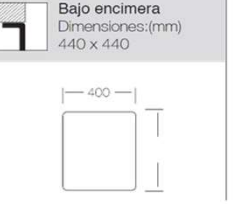
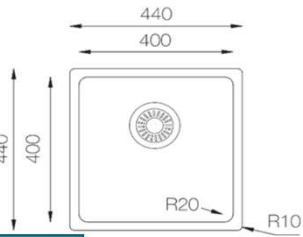

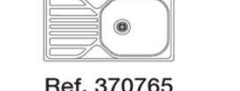
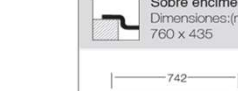

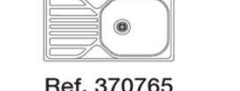
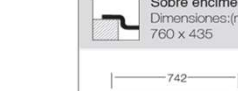
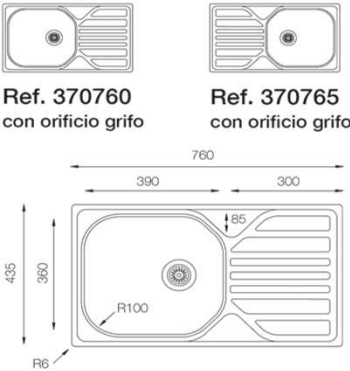
AMSTERDAN 20 405,00

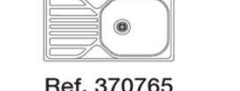
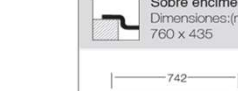

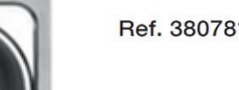
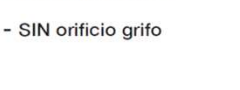
AMSTERDAM 10 365,00

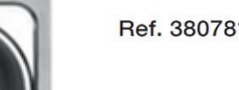
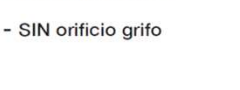

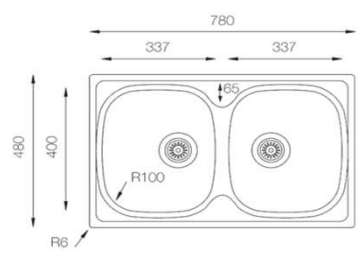
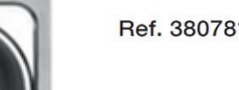
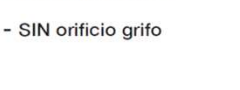
FREGADEROS INOX

| | REF. | € | | REF. | € | | | | | | | | | | |
|---|--|---|---|----------------|----------------|---------------|-------------------------------|-------------------------------|-------------------------------|---|--|---|--|--|--|
|  | | | <table border="1"> <tr> <th>Enrasado</th> <th>Sobre encimera</th> <th>Bajo encimera</th> </tr> <tr> <td>Dimensiones:(mm) 540 x 440</td> <td>Dimensiones:(mm) 540 x 440</td> <td>Dimensiones:(mm) 540 x 440</td> </tr> <tr> <td></td> <td></td> <td></td> </tr> </table> | Enrasado | Sobre encimera | Bajo encimera | Dimensiones:(mm) 540 x 440 | Dimensiones:(mm) 540 x 440 | Dimensiones:(mm) 540 x 440 |  |  |  | | | |
| | | | Enrasado | Sobre encimera | Bajo encimera | | | | | | | | | | |
| Dimensiones:(mm) 540 x 440 | Dimensiones:(mm) 540 x 440 | Dimensiones:(mm) 540 x 440 | | | | | | | | | | | | | |
|  |  |  | | | | | | | | | | | | | |
|  | <p>Mueble soporte: 600mm Profundidad: 200mm Medidas cubeta: 500x400mm Medidas exteriores: 540x440mm Espesor chapa: 1mm Acabado: Pulido</p> | | | | | | | | | | | | | | |
| LUXORS/E y B/E(54x44cm) | 340725040 | 185,00 | | | | | | | | | | | | | |
|  | | | <table border="1"> <tr> <th>Enrasado</th> <th>Sobre encimera</th> <th>Bajo encimera</th> </tr> <tr> <td>Dimensiones:(mm) 440 x 440</td> <td>Dimensiones:(mm) 440 x 440</td> <td>Dimensiones:(mm) 440 x 440</td> </tr> <tr> <td></td> <td></td> <td></td> </tr> </table> | Enrasado | Sobre encimera | Bajo encimera | Dimensiones:(mm) 440 x 440 | Dimensiones:(mm) 440 x 440 | Dimensiones:(mm) 440 x 440 |  |  |  | | | |
| | | | Enrasado | Sobre encimera | Bajo encimera | | | | | | | | | | |
| Dimensiones:(mm) 440 x 440 | Dimensiones:(mm) 440 x 440 | Dimensiones:(mm) 440 x 440 | | | | | | | | | | | | | |
|  |  |  | | | | | | | | | | | | | |
|  | <p>Mueble soporte: 450mm Profundidad: 200mm Medidas cubeta: 400x400mm Medidas exteriores: 440x440mm Espesor chapa: 1mm Acabado: Pulido</p> | | | | | | | | | | | | | | |
| LUXOR S/E y B/E(44x44cm) | 340724040 | 167,00 | | | | | | | | | | | | | |
|  | | | <table border="1"> <tr> <th>Enrasado</th> <th>Sobre encimera</th> <th>Bajo encimera</th> </tr> <tr> <td>Dimensiones:(mm) 440 x 440</td> <td>Dimensiones:(mm) 440 x 440</td> <td>Dimensiones:(mm) 440 x 440</td> </tr> <tr> <td></td> <td></td> <td></td> </tr> </table> | Enrasado | Sobre encimera | Bajo encimera | Dimensiones:(mm) 440 x 440 | Dimensiones:(mm) 440 x 440 | Dimensiones:(mm) 440 x 440 |  |  |  |  | | |
| | | | Enrasado | Sobre encimera | Bajo encimera | | | | | | | | | | |
| Dimensiones:(mm) 440 x 440 | Dimensiones:(mm) 440 x 440 | Dimensiones:(mm) 440 x 440 | | | | | | | | | | | | | |
|  |  |  | | | | | | | | | | | | | |
| <p>Ref. 370760 con orificio grifo Ref. 370765 con orificio grifo</p> | <p>Mueble soporte: 450mm Profundidad: 165mm Medidas cubeta: 390x360mm Medidas exteriores: 760x435mm Espesor chapa: 0,60mm Acabado: Satinado</p> | | | | | | | | | | | | | | |
| GENOVA S/E (78x48cm) | 340770781 | 110,00 | | | | | | | | | | | | | |
|  | | | <table border="1"> <tr> <th>Enrasado</th> <th>Sobre encimera</th> <th>Bajo encimera</th> </tr> <tr> <td>Dimensiones:(mm) 440 x 440</td> <td>Dimensiones:(mm) 440 x 440</td> <td>Dimensiones:(mm) 440 x 440</td> </tr> <tr> <td></td> <td></td> <td></td> </tr> </table> | Enrasado | Sobre encimera | Bajo encimera | Dimensiones:(mm) 440 x 440 | Dimensiones:(mm) 440 x 440 | Dimensiones:(mm) 440 x 440 |  |  |  |  | | |
| | | | Enrasado | Sobre encimera | Bajo encimera | | | | | | | | | | |
| Dimensiones:(mm) 440 x 440 | Dimensiones:(mm) 440 x 440 | Dimensiones:(mm) 440 x 440 | | | | | | | | | | | | | |
|  |  |  | | | | | | | | | | | | | |
| <p>Ref. 380780 - con orificio grifo Ref. 380781 - SIN orificio grifo</p> | <p>Mueble soporte: 800mm Profundidad: 140/140mm Medidas cubeta: 337x400mm Medidas exteriores: 780x480mm Espesor chapa: 0,60mm Acabado: Satinado</p> | | | | | | | | | | | | | | |
| BRESCIA S/E (78x48cm) | 340780780 | 126,00 | | | | | | | | | | | | | |

MONOMANDOS FREGADERO

| | REF. | € |
|-------------------|-----------|--------|
| (11cm) CAÑO 30 cm | 402133460 | 103,15 |
| K8 | | |
| (15cm) CAÑO 30 cm | 402133470 | 104,19 |
| (15cm) CAÑO 21 cm | 402133475 | 87,54 |



BASIK

| | |
|----------------------------|-------|
| 402169192 | 90,49 |
| FREGADERO CAÑO MURAL 15 cm | |



| | | |
|-----------|-------|--|
| K8 | | |
| 402133440 | 65,58 | |



BASIK

| | |
|---------------------------|-------|
| 402169200 | 56,08 |
| FREGADERO CAÑO HORIZONTAL | |



| | | |
|-----------|--------|--|
| 402133499 | 153,65 | |
| extraible | | |
| K8 | | |
| 402133599 | 127,94 | |
| extraible | | |



| | | |
|--------------|--------|--|
| KORAL | | |
| FREGADERO | | |
| 402168105 | 149,97 | |



| | | |
|-----------|-------|--|
| K8 | | |
| 402133456 | 99,66 | |



BASIK

| | |
|---------------------------|-------|
| 402169203 | 80,84 |
| FREGADERO CAÑO CONFORMADO | |



MONOMANDOS FREGADERO

| REF. | | € | REF. | | € |
|---|---|--------|--|------------------------------------|--------|
|  | <p>TAU MONOMANDO FREGADERO CAÑO FLEXIBLE CROMO-NEGRO</p> | |  | <p>COLUMNA PRELAVADO</p> | |
| | 402065219 | 241,05 | | 401471159 | 402,58 |
|  | <p>TAU MONOMANDO NEGRO</p> | |  | <p>VULCANO 6999 MEDICAL</p> | |
| | 402121301 | 178,13 | | 400526999 | 69,87 |
|  | <p>OSMOSIS CAÑO FLEXIBLE</p> | |  | <p>TITANIUM 1806</p> | |
| | 400598988 | 334,56 | | 400501806 | 73,23 |
|  | <p>OSMOSIS 3 VÍAS</p> | |  | <p>TITANIUM 1836</p> | |
| | 402065702 | 228,94 | | 400501836 | 69,87 |
| | <p>NEGRO</p> | | | <p>TITANIUM 1836</p> | |
| | 402065703 | 337,78 | | | |
| <p>INOX</p> | | | | | |
| 402065704 | 358,04 | | | | |



CONSULTA NUESTRA

GAMA DE

ELECTRODOMÉSTICOS





Almacén de Fontanería

**PISCINAS - FOSAS Y DEPURADORAS -
TRATAMIENTOS DE AGUA - AEROTERMIA -
CALEFACCIÓN - GRIFERÍAS - MATERIAL
CONTRAINCENDIOS - GAS -
DESCALCIFICADORES - SANITARIOS -
ACCESORIOS PARA BAÑOS PÚBLICOS -
BOMBAS DE AGUA - VALVULERÍA -
TUBERIAS - VENTILACIÓN - DEPÓSITOS -
MÁQUINAS - HERRAMIENTAS - TERMOS -
ACUMULADORES - AIRE ACONDICIONADO**

Siempre Cerca de tí

ALMACÉN

C/ JUAN RAMÓN JIMÉNEZ, 11-13
46930 QUART DE POBLET
TEL. 961548962

quart@suministroscoplasa.com

**ALMACÉN - OFICINAS
SHOWROOM**

C/ DOMINGO GÓMEZ, 23
46025 VALENCIA
TEL. OFICINAS: 963471573
TEL. ALMACÉN: 963473527

valencia@suministroscoplasa.com

www.suministroscoplasa.com



ALMACÉN

C/ TANDA XICA, 29 - NAVE 2
P.I. CAMÍ DE LA VILA
46800 XÁTIVA
TEL. 961712387

xativa@suministroscoplasa.com

**14ª Feria del
Instalador**